

LINE 2000

PLANNING DATA

Technical Specifications

LINE 2000

Rated Load (kg) (max P+Q=2050)	300	450	630	1000
Persons	4	6	8	13
Suspension	2:1			
max Travel (m)	50			
Stops	18			
max Car Speed (m/sec)	1,6			
min Pit (mm)	1100 without compensation chain / 1200 with compensation chain (Car Speed 1,0 m/sec) 1250 without compensation chain / 1300 with compensation chain (Car Speed 1,6 m/sec)			
min Headroom (mm) *	3450 (Car Speed 1,0 m/sec)		3600 (Car Speed 1,6 m/sec)	
Car Sling Weight (kg)	180~250			
max Car Sling Weight (doors included) (kg)	700	700	870	800
Car Guide Rails / Cwt Guide Rails	T75x62x10 C / T50x50x5 C			T89x62x16 C / T50x50x5 C
Car dbg (mm)	1000 ~ 1850 mm per 50mm			
Counterweight dbg (mm)	700			800
max Vertical Distance Between Brackets (mm)	2000			
Ropes	DRAKO 250T Ø6.5			

P	900	1100	Max 1050
Number of Ropes	6 x Ø6.5	7 x Ø6.5	8 x Ø6.5
Gear Type / Inverter	ERS / GEFTRAN		ERS / GEFTRAN
Gear Current (Nominal) (A) 1m/	10.3 ~ 14.9		16.6 ~ 24.5
Gear Power (KW)	4.0 ~ 6.4		6.3 ~ 10.2

- for v=1.0m/s, cabin external height 2340 mm and car door 2000 mm

Overspeed governor	KLG1.0 – KLG1.6
Overspeed governor ropes	DRAKO Ø8mm 8x19S, min breaking load 30400N
Electronic overload	DS-Europe MRL for Ø6.5 mm ropes
Cabin type	<ul style="list-style-type: none"> • MODERN LIFE (L320, L310) • CLASSIC ATHENA (A310)
Controller	KLLC 100

FORCES ON SHAFT

a. Forces on pit floor

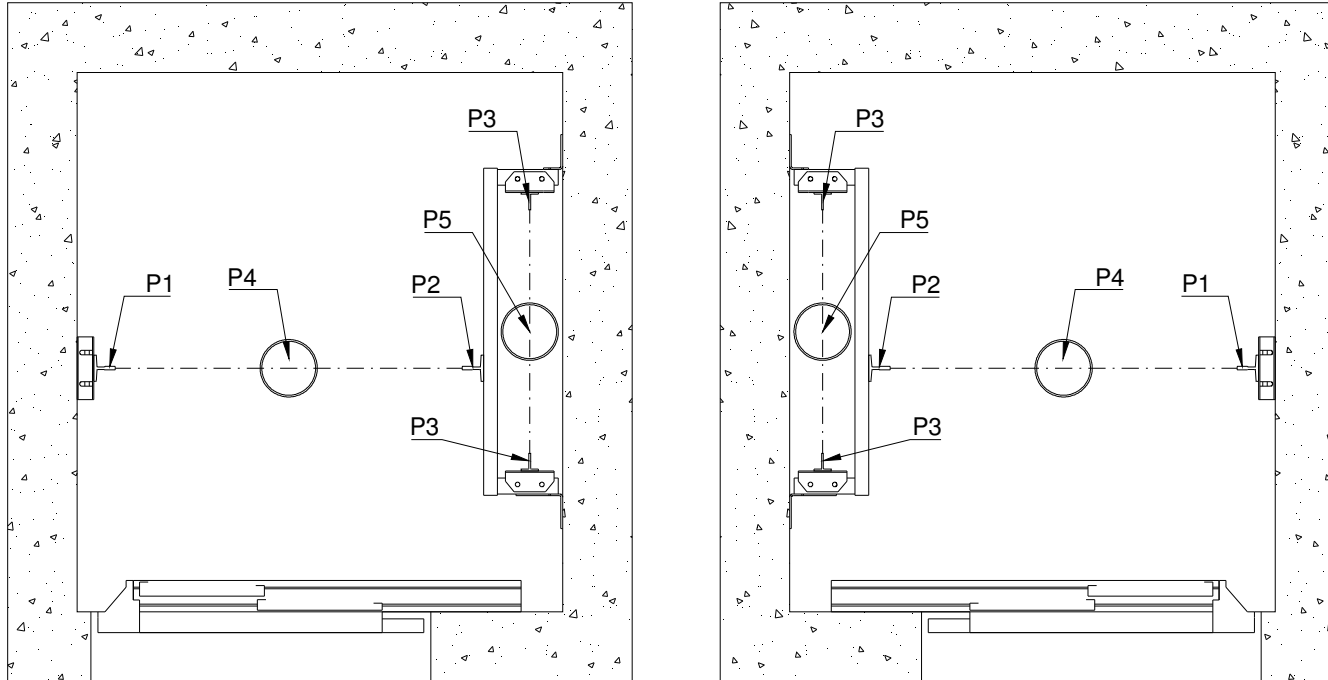

RATED LOAD[Kg]	300~375	450	630	1000	Notes
P1 [KN]	12.5	13.3	17	20	
P2 [KN]	28	29	37	42	
P3 [KN]	16	16.6	21	23	Only in cwt with safety gear
P4 [KN]	50	53	68	81	
P5 [KN]	43	44	56	61	

b. Forces on headroom walls

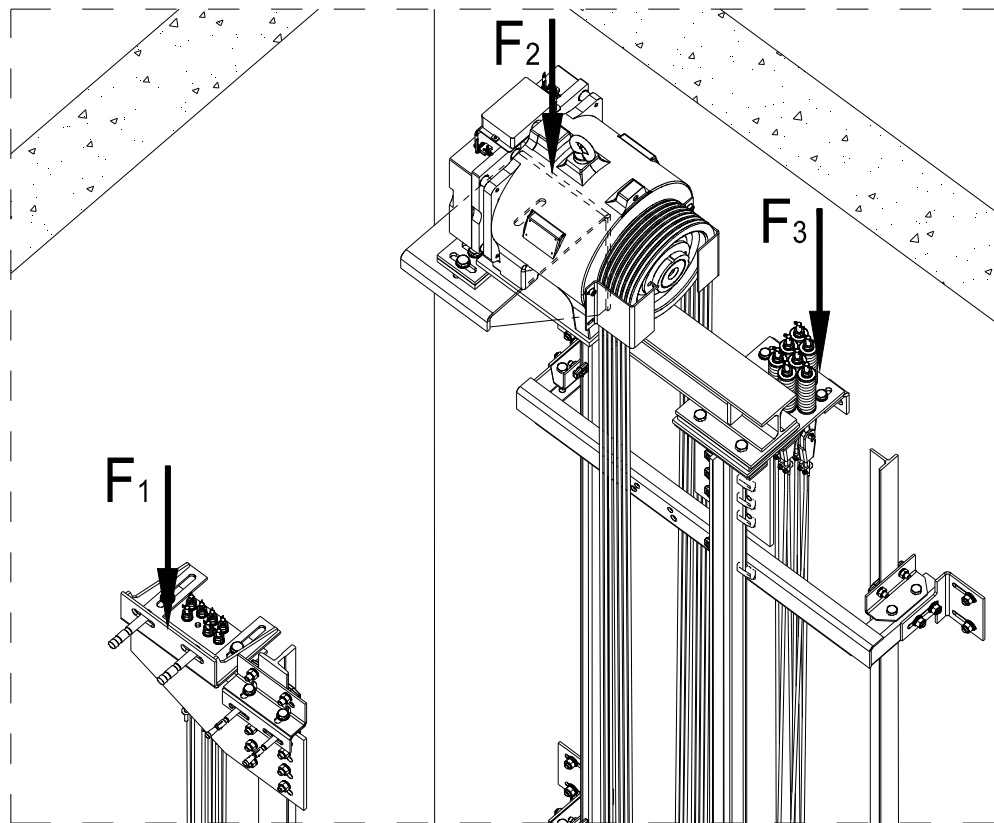

RATED LOAD (kg)	300~375	450	630	1000
F_1 [KN]	14.5	15.3	17.0	20.2
F_2 [KN]	11.2	11.6	12.6	13.5
F_3 [KN]	8	8.2	8.7	9.6

LINE 2000 (375 Kg / 5 persons / Available car area 900x1150)
Side-opening doors

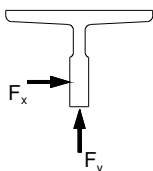
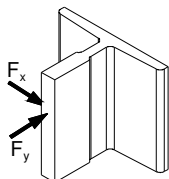
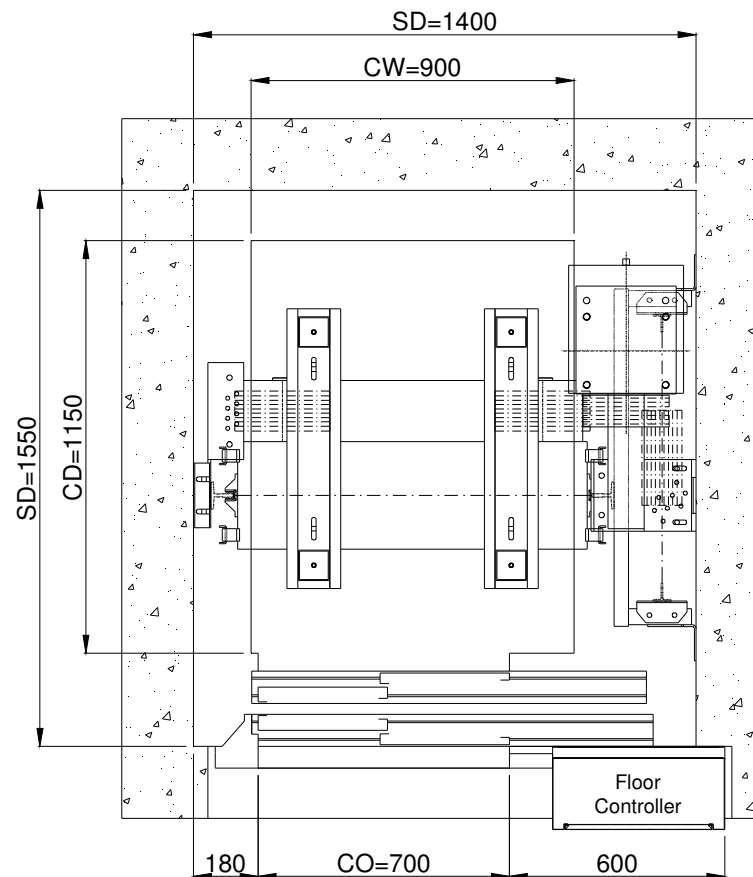

F_x	1013 N
F_y	463 N

Note:
Shaft Width is given for surface mounted COP.
Otherwise, Shaft Width must be increased by 50mm

LINE 2000 (450 Kg / 6 persons / Available car area 1000x1250)
Side-opening doors

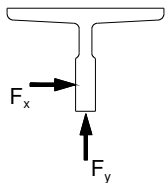
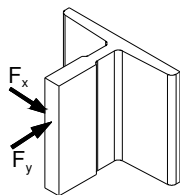
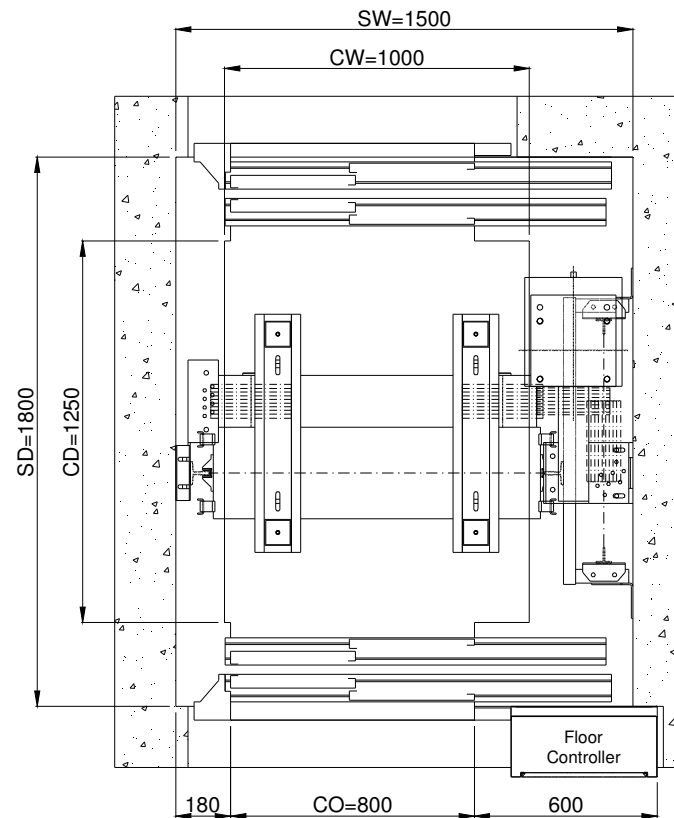
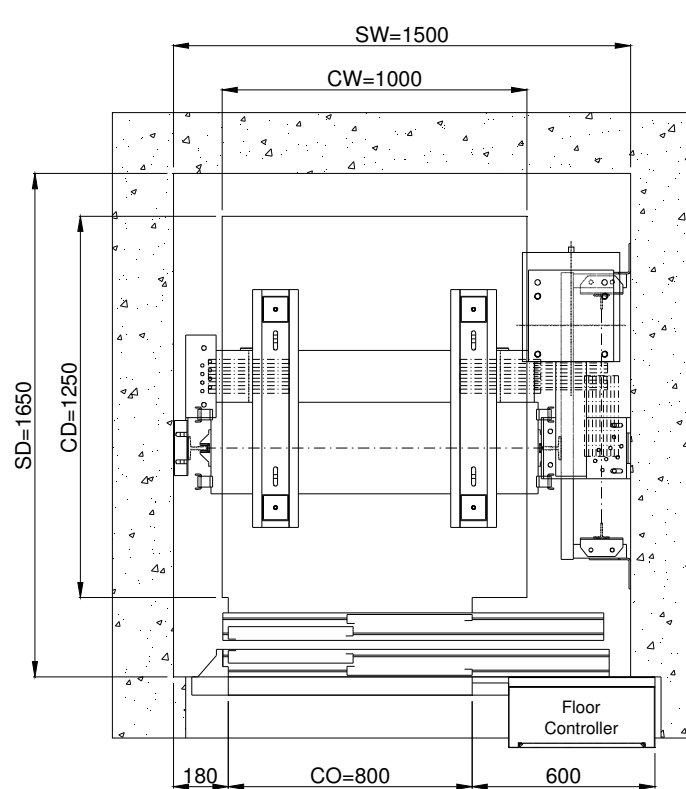

F_x	1104 N
F_y	569 N

Note:
Shaft Width is given for surface mounted COP.
Otherwise, Shaft Width must be increased by 50mm

LINE 2000 (630 Kg / 8 persons / Available car area 1100x1400)
Side-opening doors

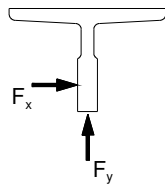
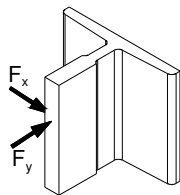
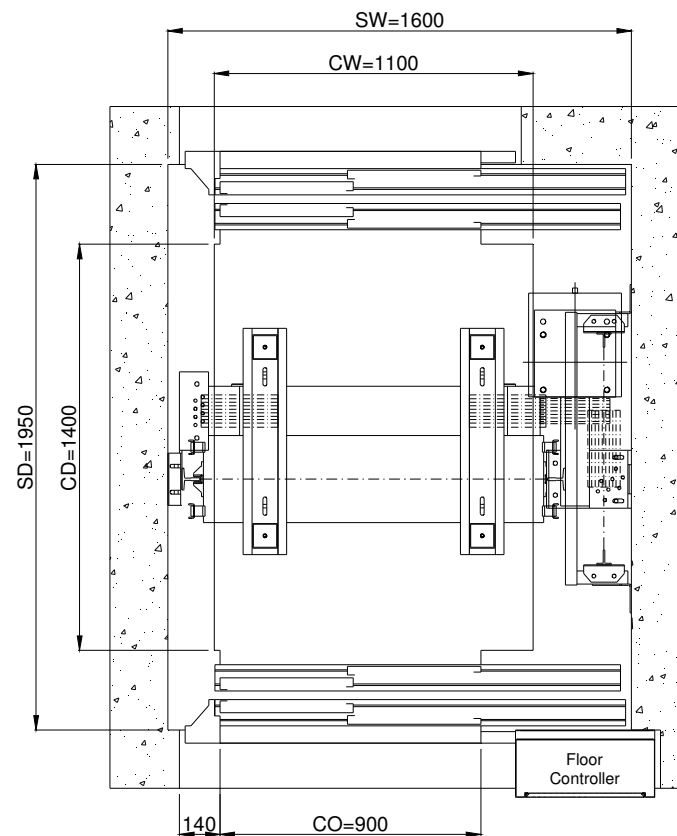
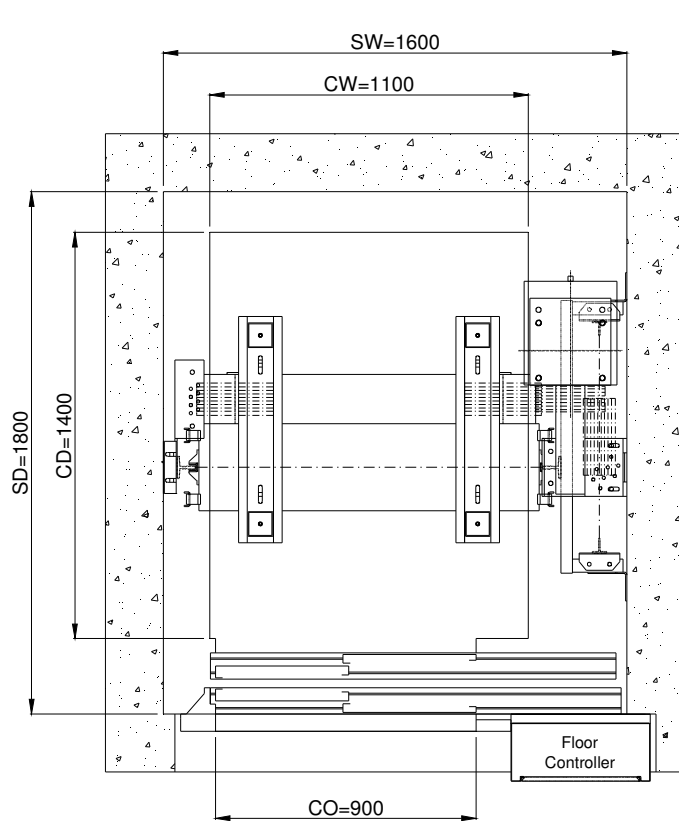

F_x	1460 N
F_y	829 N

Note:
Shaft Width is given for surface mounted COP.
Otherwise, Shaft Width must be increased by 50mm

LINE 2000 (1000Kg / 13 persons / Available car area 1100x2100)
Side-opening doors

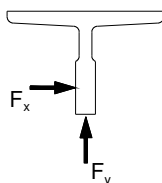
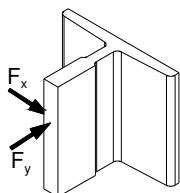
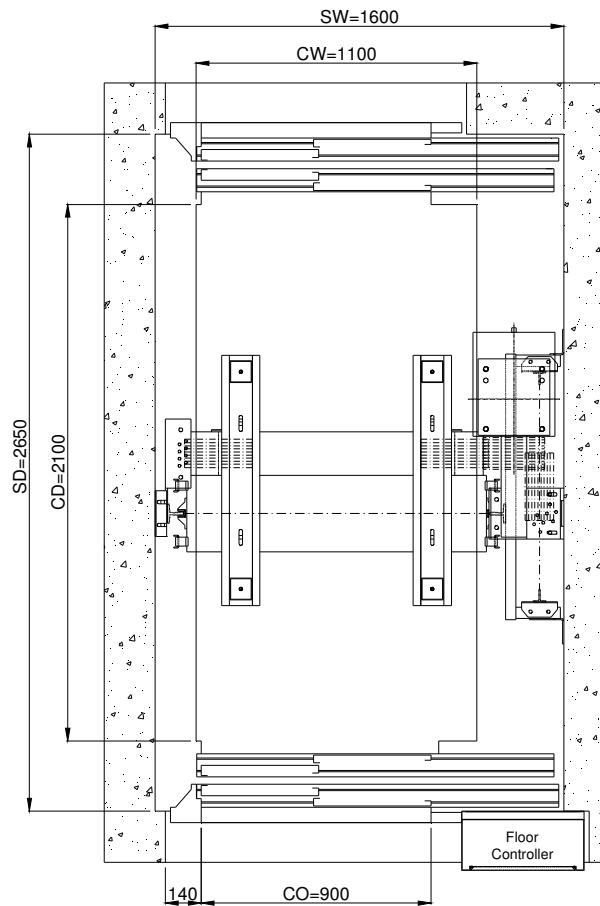
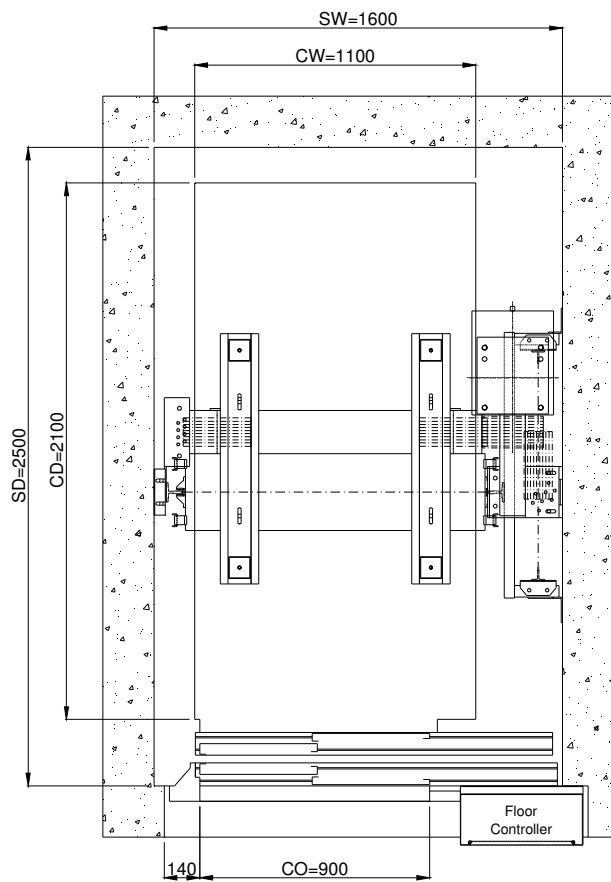

F_x	2070 N
F_y	1220 N

Note:
Shaft Width is given for surface mounted COP.
Otherwise, Shaft Width must be increased by 50mm

LINE 2000(1000 Kg / 13 persons / Available car area 1400x1600)
Side-opening doors

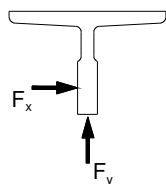
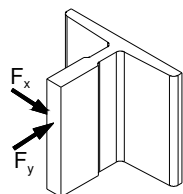
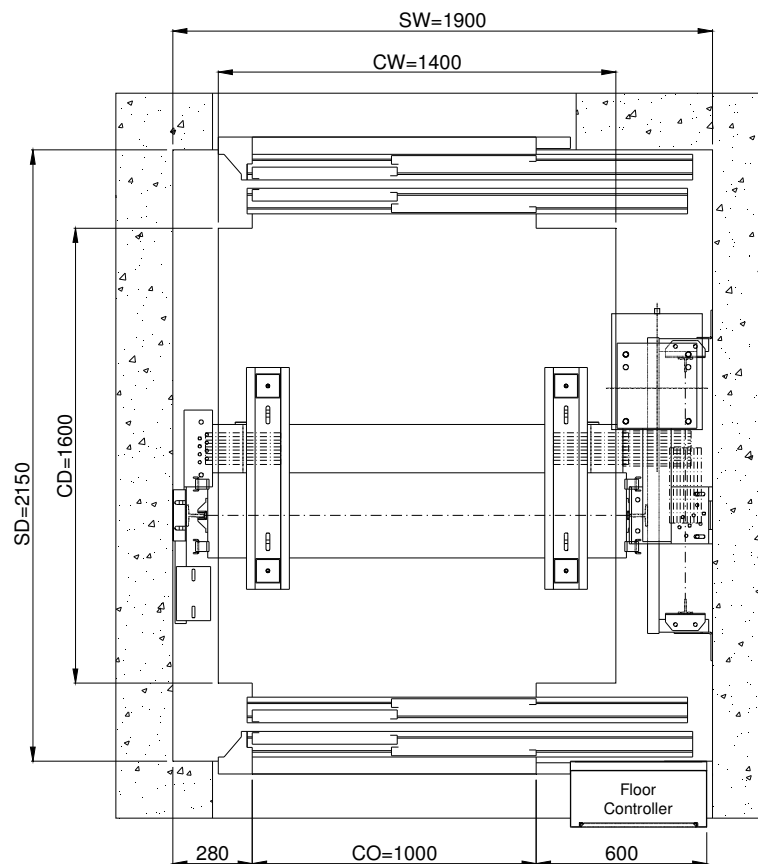
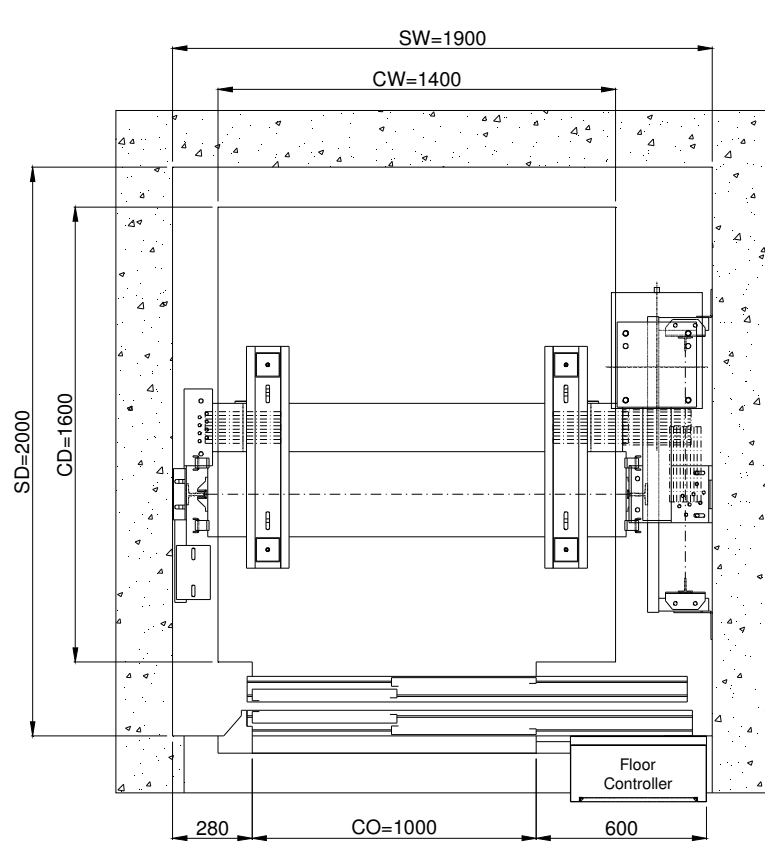

F_x	2044 N
F_y	1477 N

Note:

Shaft Width is given for surface mounted COP.
Otherwise, Shaft Width must be increased by 50mm

LINE 2000 (1000 Kg / 13 persons / Available car area 1400x1600)
Central-opening doors

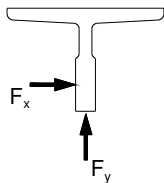
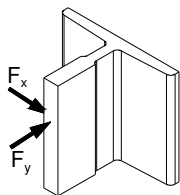
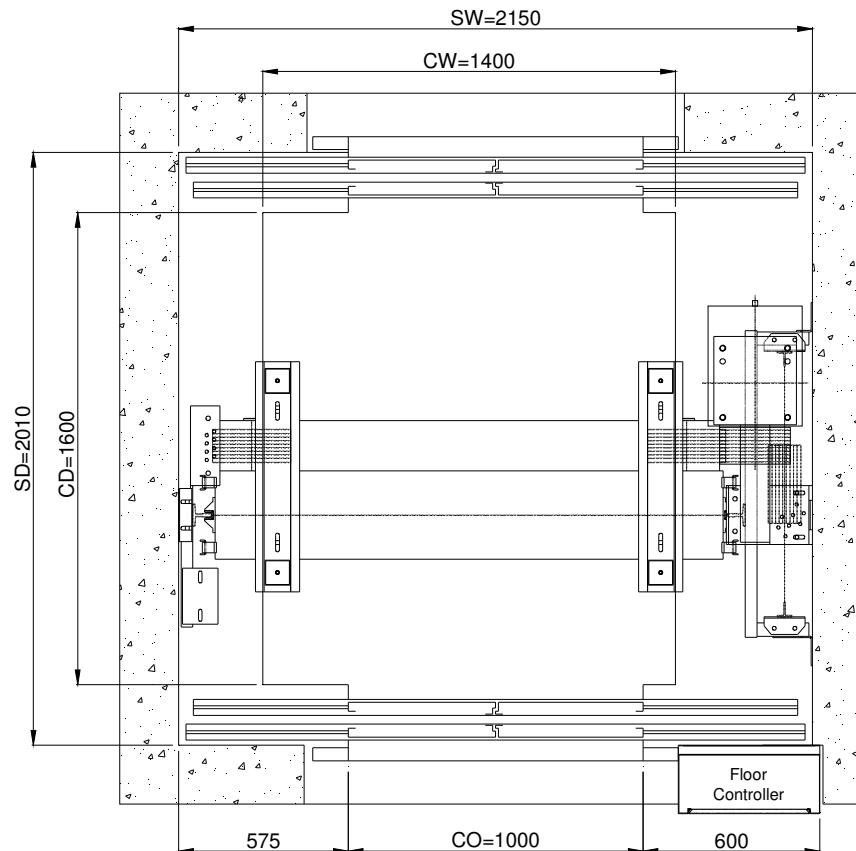
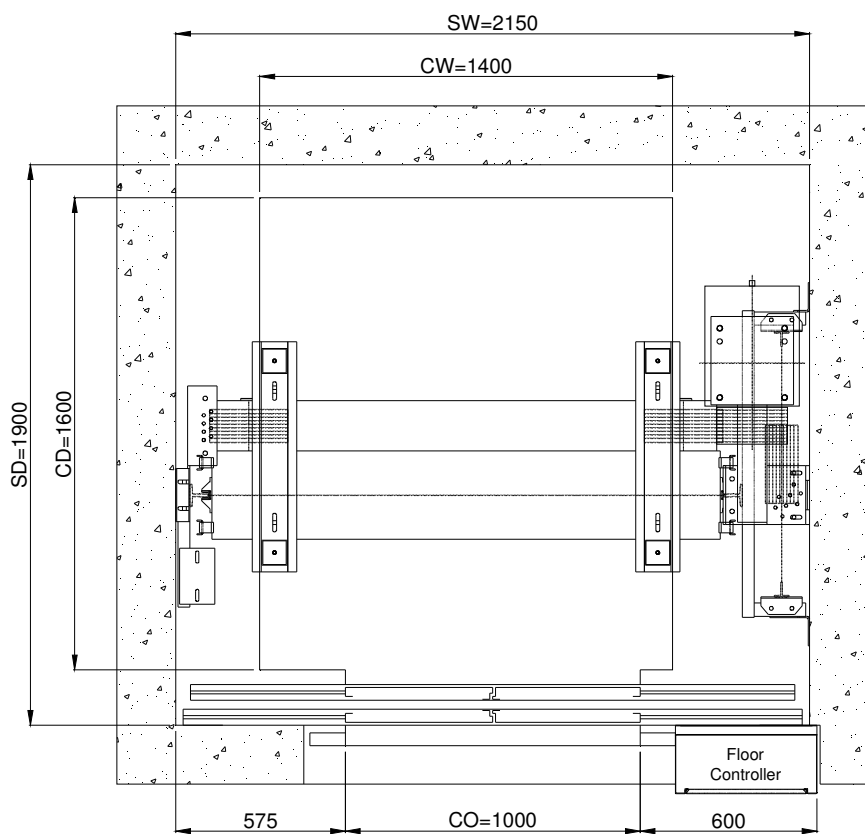

F_x	2044 N
F_y	1477 N

Note:
Shaft Width is given for surface mounted COP.
Otherwise, Shaft Width must be increased by 50mm

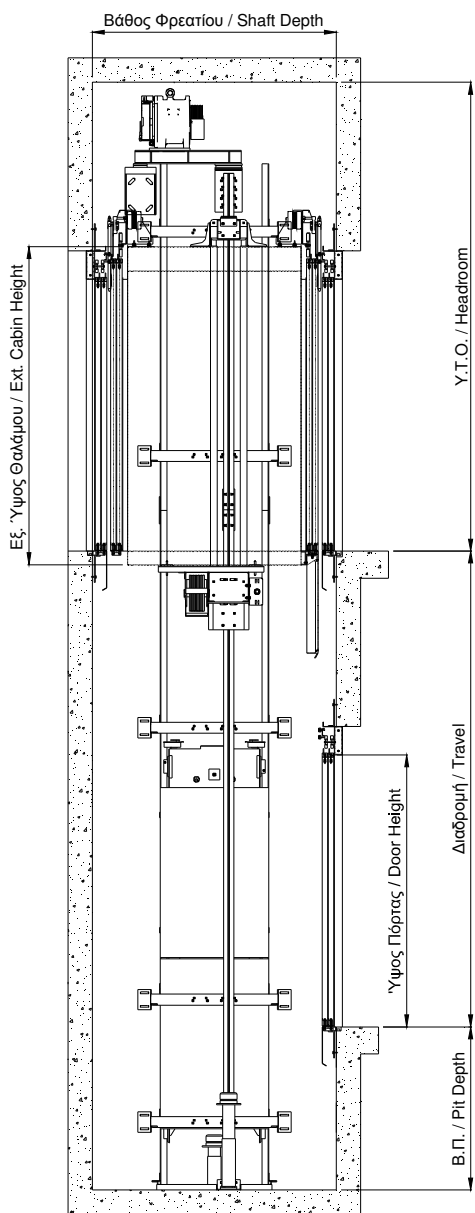

Single Entrance Cabin					
External Cabin Height [mm]	Door Height [mm]	$v \leq 1.0 \text{ m/s}$		$1.0 < v \leq 1.6 \text{ m/s}$	
		Min. Pit	Min. Headroom	Min. Pit	Min. Headroom
2340	2000	1100	3450	1200	3600
	2100				
2440	2000	1100	3550	1200	3700
	2100				

Through Cabin					
External Cabin Height [mm]	Door Height [mm]	$v \leq 1.0 \text{ m/s}$		$1.0 < v \leq 1.6 \text{ m/s}$	
		Min. Pit	Min. Headroom	Min. Pit	Min. Headroom
2340	2000	1100	3450	1200	3600
	2100		3550		3700
2440	2000	1100	3550	1200	3700
	2100				