

ATLAS mini

PLANNING DATA

Technical specifications	
Rated Load (Kg)	180 έως 450
Number of Passengers	2 έως 6
Suspension	2:1
max Travel (m)	30
Number of Stops	11
max Car Speed (m/sec)	1.0
min Pit Height (mm) *	350
min Headroom Height (mm) *	2950
Car Sling Weight (Kg)	~ 136
max Empty Car Weight P (Kg) (Sling + Cabin + Car Door)	630
Car Guide Rails / Cwt Guide Rails	T75x62x10 / T50x50x5
max Vertical Distance between Brackets (mm)	1500
Wire Ropes	DRAKO 250T Ø6,5
Number of Wire Ropes	6
Machine Type	ZIEHL-ABEGG SM160
Current (Nominal) (A)	9
Power (kW)	3.3
Car DBG (mm)	700 / 800 / 900
Cwt dbg (mm)	724 / 824 / 924

Traction Gearless Lift certified according to 95/16/EC Lift Directive

* Under certain circumstances. Contact KLEEMANN Export Sales department

FORCES ON SHAFT

Forces on pit floor

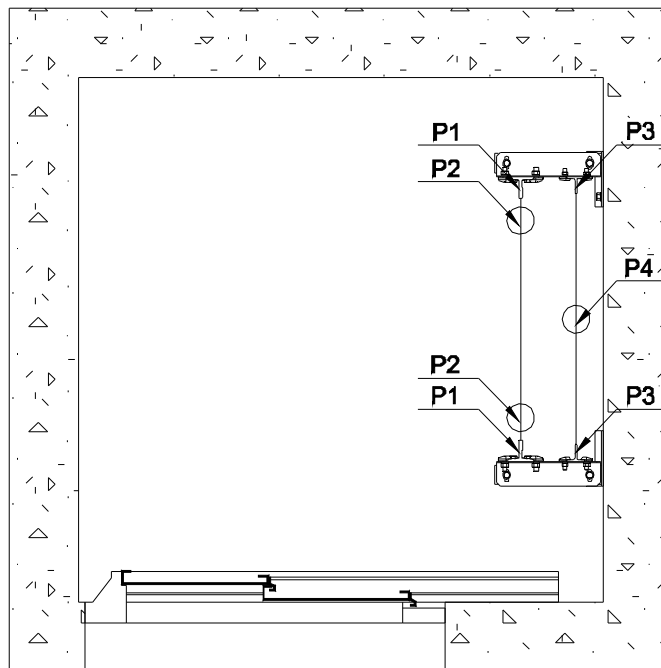

Rated Load [kg]	180	225	320	375	450
P1 [kN]	16.2	17.5	18.8	20.6	22.1
P2 [kN]	15.6	17.1	18.6	20.1	21.6
P3 [kN]	8.5	9.1	9.6	10.2	10.8
P4 [kN]	28.2	29.7	31.2	32.7	34.2

**ATLAS mini (225 kg / 3 Passengers / Available car area 800x800)
Semi - Automatic Door**

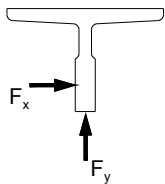
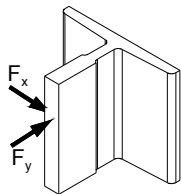
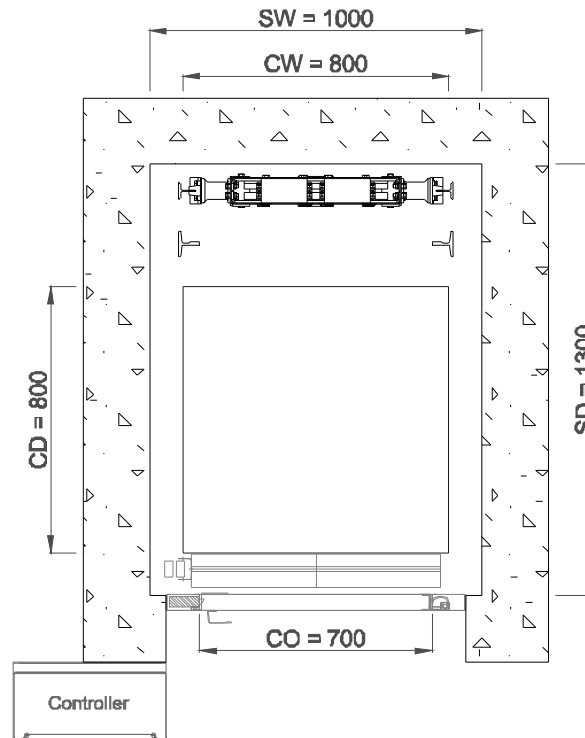

F_x	2527 N
F_y	200 N

**ATLAS mini (320 kg / 4 Passengers / Available car area 900x1000)
Semi - Automatic Door**

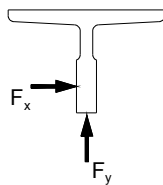
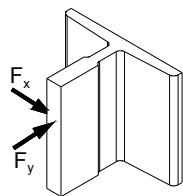
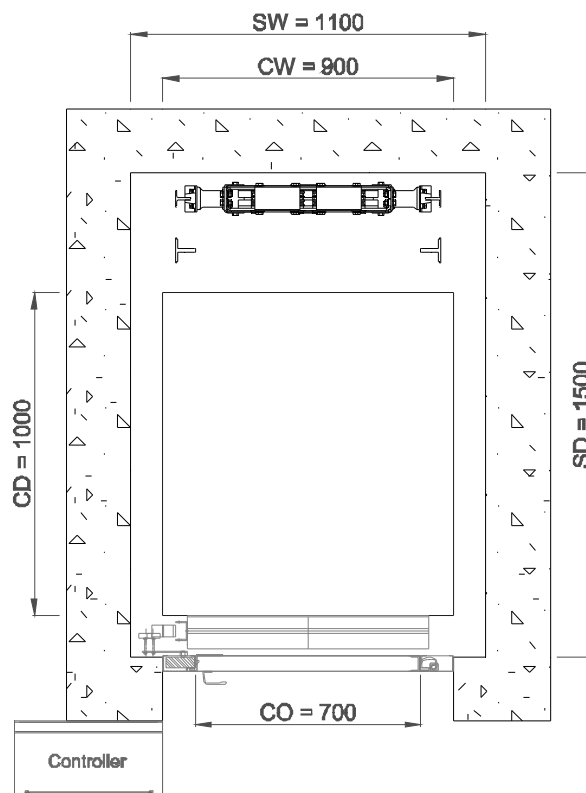

F_x	2780 N
F_y	300 N

**ATLAS mini (320 kg / 4 Passengers / Available car area 900x1000)
Side-opening Door**

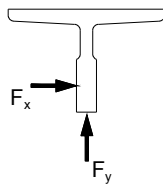
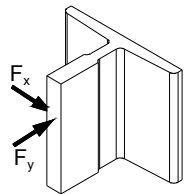
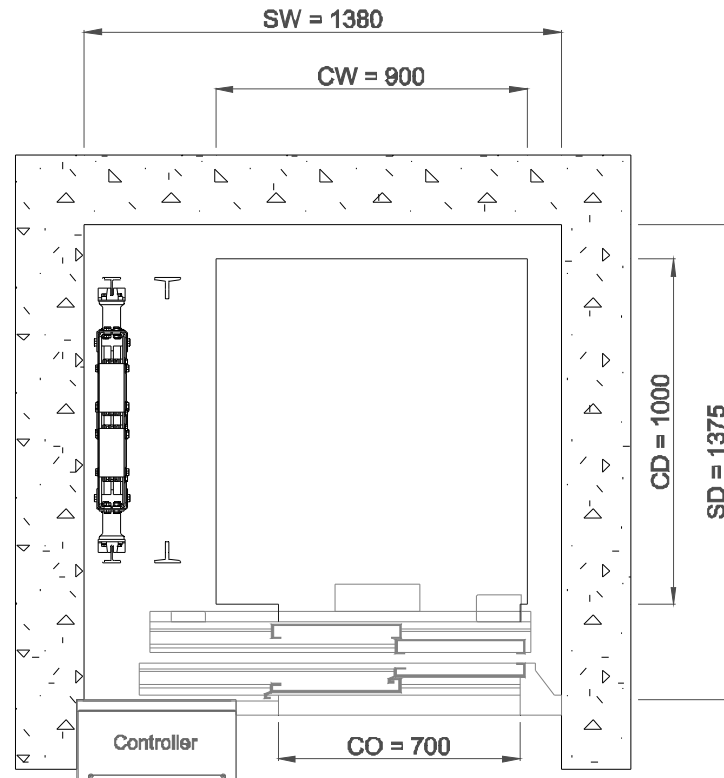

F_x	2556 N
F_y	334 N

**ATLAS mini (375 Kg / 5 Passengers / Available car area 1000x1050)
Side-opening Door**

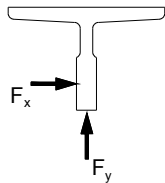
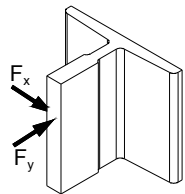
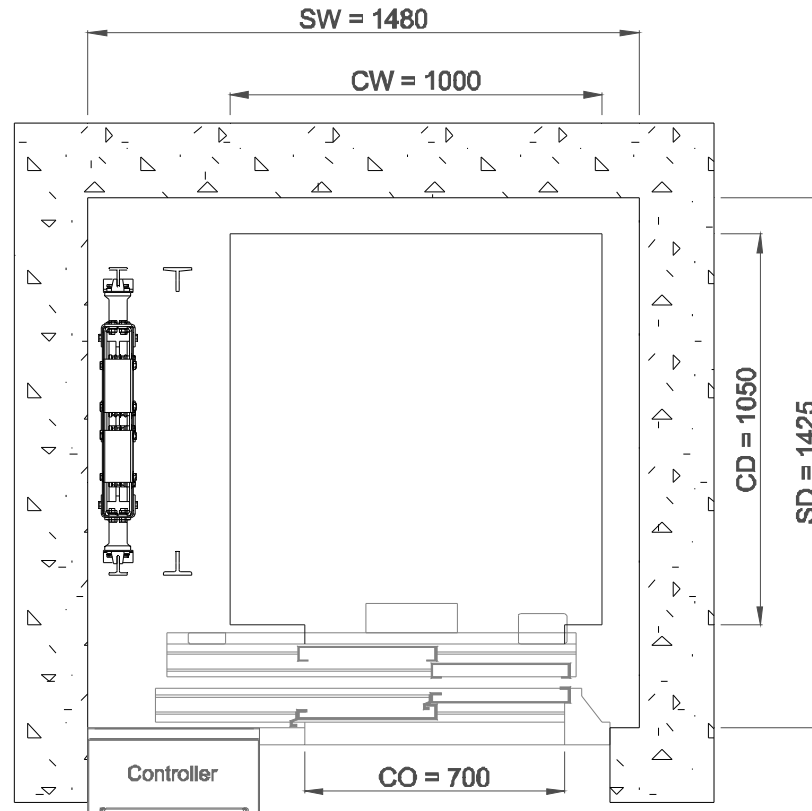

F_x	3032 N
F_y	460 N

**ATLAS mini (450Kg / 6 Passengers / Available car area 1100x1100)
Side-opening Door**

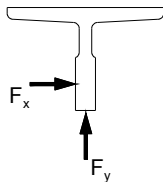
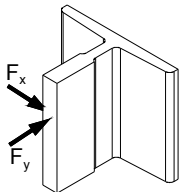
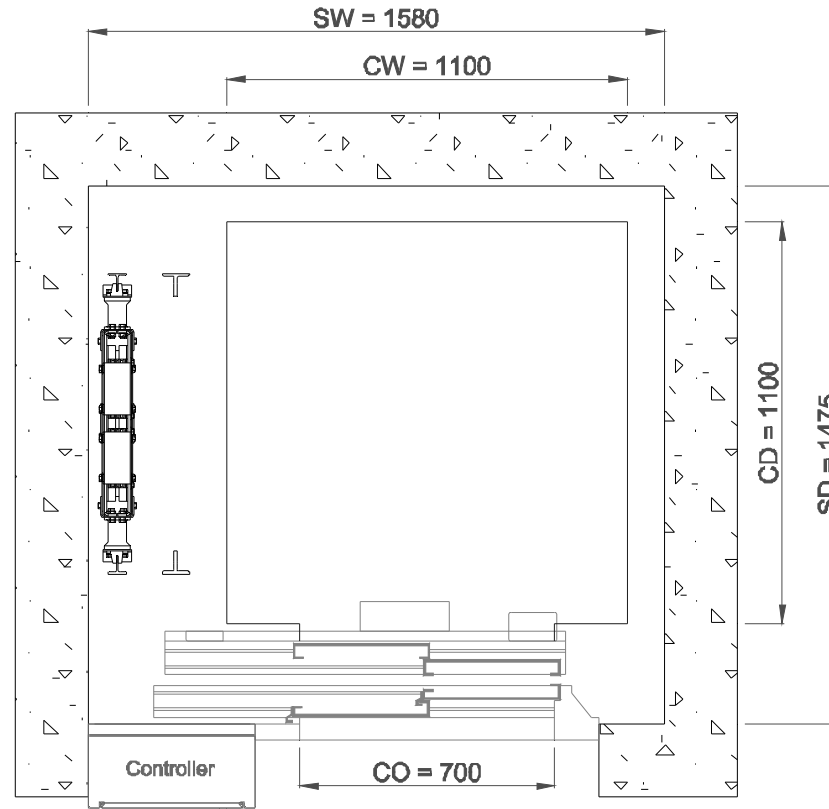

F_x	3285 N
F_y	577 N

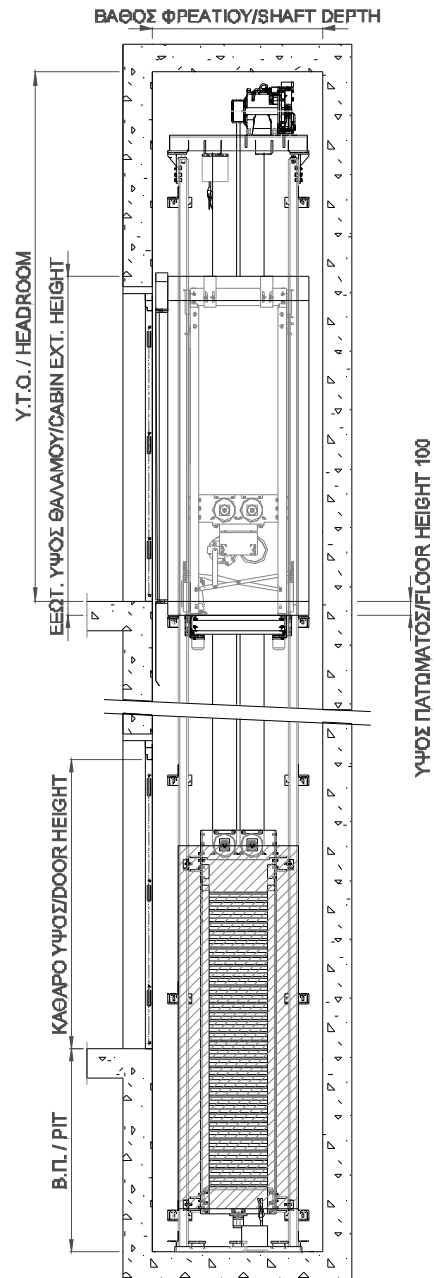

Side frame height h [mm]	max. External Cabin Height = h - 60 [mm]	Pit Height [mm] (min. 350mm)	Headroom Height (min. 2950mm)
2400	2340	Floor Height + 285	h + 550
2490	2430		
2550	2490		